



# ***CAVIBLASTER***<sup>®</sup>

CAVIDYNE LLC  
5077 Fruitville Rd., Suite  
109-157 Sarasota, FL 34232  
Phone: (352) 275-5319

# **Operation & Maintenance Manual**



**Model 3040-E**



CAVIDYNE LLC is not responsible for damages or injuries resulting from a failure to comply with instructions in this manual. Please read and study the entire manual carefully before use.



The CaviBlaster model 3040-E60 must only be operated and maintained by trained personnel.



This equipment generates high pressure water and is intended for underwater use only. **Serious personal injury or death may result from improper use.**



Commercial Diver's gear should be used to operate the CaviBlaster system.



Electric shock can cause severe burns or death. Ground system before connecting power supply. Use dedicated circuit installed by a licensed electrician. Circuit should supply adequate voltage and amperage under load.



**CAUTION: DO NOT USE THIS EQUIPMENT TO CLEAN SENSITIVE SURFACES** as LED-Lights, Underwater Lights, Electronic Equipment, etc.

# Table of Contents

<b>1.0 UNIT SPECIFICATIONS.....</b>	<b>5</b>
<b>2.0 GENERAL DESCRIPTION.....</b>	<b>6</b>
2.1 Using this manual .....	10
2.2 Conventions .....	10
2.3 Scope .....	10
2.4 Terms and Abbreviations .....	11
<b>3.0 SAFETY INFORMATION.....</b>	<b>12</b>
3.1 Personal Safety .....	12
3.2 Personal Protective Equipment.....	13
3.3 Modification to the Equipment.....	14
<b>4.0 INSTALLATION .....</b>	<b>15</b>
4.1 Uncrating and Lifting.....	15
4.2 Installation Location .....	16
4.3 Initial Set-Up .....	17
4.3.1 Connecting the Water Source .....	18
4.3.2 Priming the System Using the Feed Pump System .....	18
4.3.3 Water Supply Conditions.....	19
<b>5.0 OPERATION .....</b>	<b>22</b>
5.1 Preparing the CaviBlaster for Operation .....	22
5.2 Startup of the CaviBlaster .....	22
5.3 Normal Operation .....	23
5.4 Adjusting the CaviBlaster for Maximum Performance.....	24
5.5 Recommendations for Effective Results .....	26
<b>6.0 MAINTENANCE.....</b>	<b>29</b>
6.1 Basic Preventive Maintenance Recommendations .....	30
6.2 Pump Service.....	30
6.3 Inspection/Cleaning of Water Inlet Strainer .....	31
6.4 Inspection / Maintenance of the Zero-Thrust Gun .....	32
<b>7.0 WINTERIZATION.....</b>	<b>33</b>
<b>8.0 TROUBLESHOOTING.....</b>	<b>34</b>
<b>9.0 REPLACEMENT PARTS.....</b>	<b>36</b>

## Table of Figures

<i>Figure 1.1 – CaviBlaster 3040-E60 Specifications</i> .....	5
<i>Figure 2.1 – CaviBlaster 3040-E60 General Features</i> .....	7
<i>Figure 2.2 – CaviBlaster 3040-E60 Control panel</i> .....	8
<i>Figure 4.1 – Lifting Guidelines</i> .....	14
<i>Figure 4.2 – Installation Guidelines</i> .....	16
<i>Figure 4.3 – Gravity Feeding Source</i> .....	18
<i>Figure 5.1 – Zero-thrust gun Pressure Calibration</i> .....	25
<i>Figure 5.2 – Zero-thrust Gun Position for Best Results</i> .....	27
<i>Figure 6.1 – Inspection / Cleaning Water Filter/Strainer</i> .....	31
<i>Figure 6.2 – Zero-Thrust Gun</i> .....	32

**This space intentionally left blank**

## 1.0 UNIT SPECIFICATIONS

---

The CaviBlaster 3040-E60 power unit consists of a 100HP (74.5 kW) electric motor and a HPP GLR 109/290 triplex plunger pump. Detailed performance and specifications are listed below:

<b>CaviBlaster 3040-E60 Specifications</b>	
Nominal Pump Flow	29 GPM (110 LPM)
Nozzle Operating Pressure	4,000 PSI (276 BAR)
Motor	100 HP 3 PHASE 480 Volts @ 60Hz 58.5 Amp
Installation Environment	Indoor or Outdoor <i>See Section 4 for installation requirements</i>
Water Inlet Pressure Limits	0 PSI (Atmospheric Pressure) to <b>50 PSI Maximum</b> (0 BAR to <b>3.5 BAR</b> ) <i>See Section 4 for further requirements</i>
Overall Unit Dimensions (L x W x H)	63" x 47" x 50" (166 cm x 119 cm x 127 cm)
Maximum Pressure Hose Length	600 LF (200 meters) of 3/4" diameter
Power Unit Weight (Dry)	2,550 LBS (1160 KG)
Zero-Thrust Gun Weight	4.4 LBS (2 KG)

Figure 1.1 – CaviBlaster 3040-E60 Specifications

(EOS)

## 2.0 GENERAL DESCRIPTION

---

The CaviBlaster 3040-E60 high-pressure water power unit is designed to use water flow and pressure to generate cavitation at the end of the proprietary nozzle.

The CaviBlaster cleans the surface of any underwater structure using the energy released by the implosion of the bubbles created during the cavitation process. When directed at the surface being cleaned, the energy released by the collapsing bubbles causes marine growth to be removed from the surface.

The system consists of a portable, zero-thrust gun, connecting high-pressure hose and an electric motor-powered, high-pressure pumping unit. The zero-thrust gun uses a trigger-operated valve to control the water stream off and on. If the valve is closed, the power unit goes into bypass mode unloading the engine and the pump.

The CaviBlaster 3040-E60 power unit is a complete “plug and play” system built into a self-supporting frame that allows quick deployment and/or installation of the unit. Water can be supplied from either a pressurized source, directly from the natural source via an electric feed pump supplied with the power unit, or from a gravity feed storage tank.

The unit is equipped with many features to maintain operator safety while operating at pressures of 4,000 psi (276 BAR) with safety overload protection rating to 5,000 psi (344 BAR).

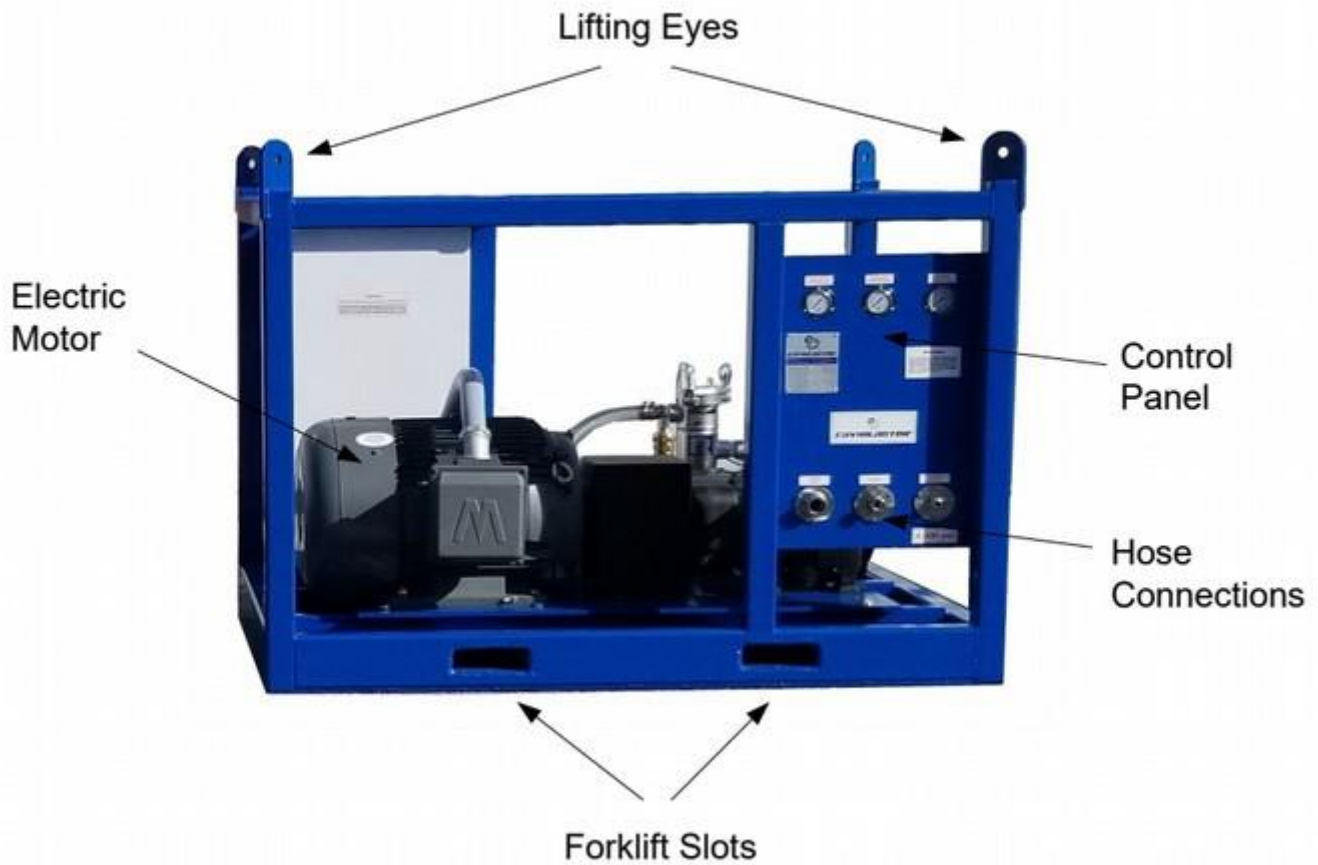
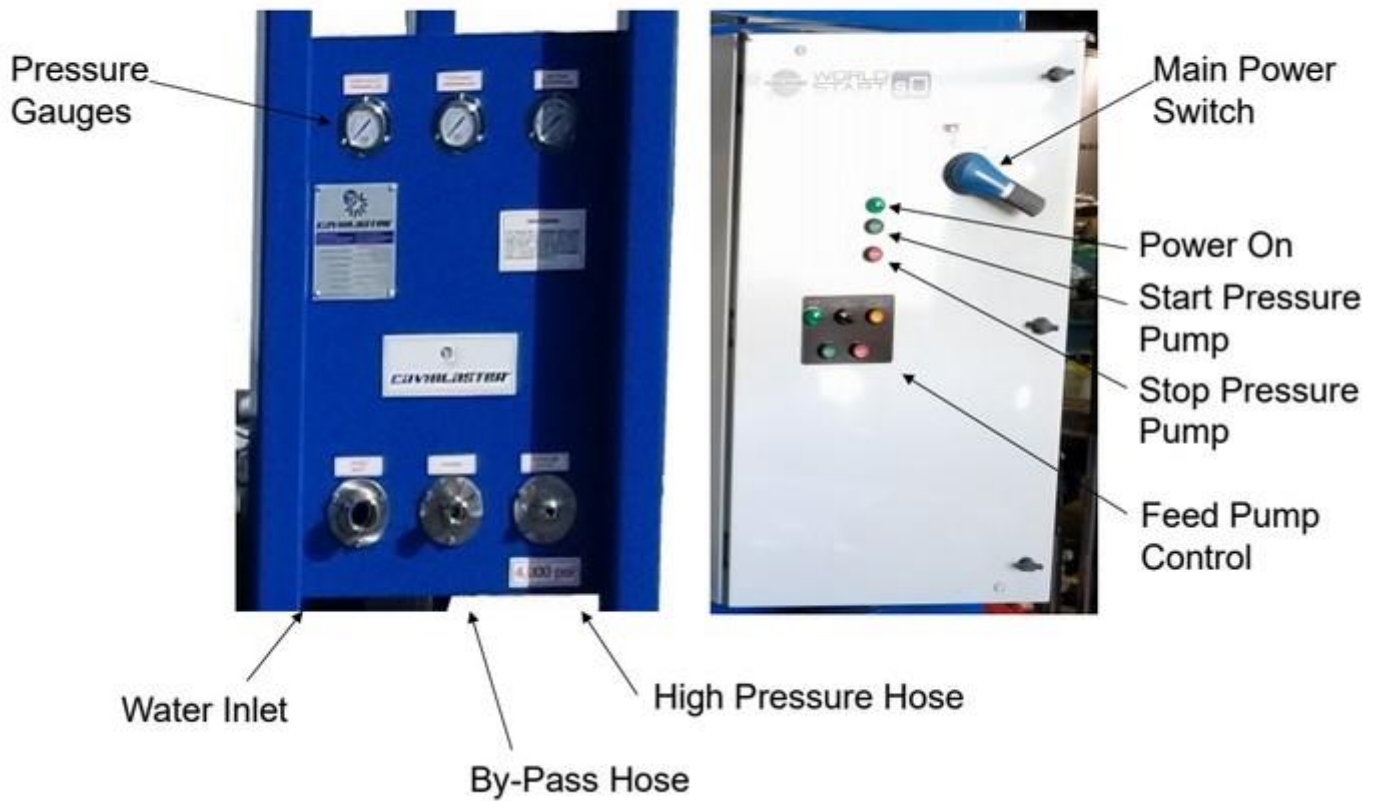

Figure 2.1 – CaviBlaster 3040-E60 General Features



*Figure 2.2 – CaviBlaster 3040-E60 Control panel*



## 2.1 Using this manual

While every effort has been made to ensure the accuracy and completeness of the content of this documentation, CaviDyne, LLC, its employees or associated organizations shall have neither liability nor responsibility to any person or entity with respect to any loss or damage arising from its use. Always take appropriate and adequate precautions to prevent damage or injury. Should you, at any time, have questions or concerns, please, contact our headquarters, as we will be happy to assist you. While quality and your satisfaction are our goal, nothing takes precedence over your safety.

## 2.2 Conventions

The first time a component is mentioned, it is typically followed by a figure reference; e.g., Emergency Stop button (See Figure 2.1). Figure numbers and section numbers are always coincident.

When other sections are referenced the *SECTION NAME* will appear in italic caps. The electronic version allows users to click on the section name or figure reference to jump to that section. The words “**This space intentionally left blank**” will appear where there is more than 3 inches of white space.

**(EOS)** will appear above the page number on the last page of each section.

## 2.3 Scope

This manual covers installation, operation, and maintenance of the CaviBlaster 3040-E60. It is essential that personnel who will operate and/or service this equipment familiarize themselves with this manual. Standard components, such as the unit motor and pump, are covered by the manufacturer’s literature found in the Appendix.

## 2.4 Terms and Abbreviations

CCW	Counterclockwise
CW	Clockwise
EOS	End of Section
GPM	Gallons Per Minute
HP	Horsepower
LPM	Liters Per Minute
PPE	Personal Protective Equipment
PSI	Pounds Per Square Inch (without suffix, assumed to be gauge pressure).
Z-T Gun	Zero-Thrust Gun
HPP	High Pressure Pump

### 3.0 SAFETY INFORMATION

---

The CaviBlaster 3040-E60 power unit is an inherently powerful and potentially dangerous piece of equipment; however, with proper care and training it can be operated safely. The 3040-E60 must only be operated by personnel that have read and understand this manual. It is intended to reinforce and review safety techniques to prevent personal injuries and property damage.

Users must comply with all local, state, and national laws concerning high-pressure water jetting equipment as well as all underwater work regulations.

It is strongly recommended that this entire manual be reviewed in-depth before operating or servicing this equipment. Service work should only be performed by individuals who are proficient in using this equipment. Refer to the applicable section in this manual for the correct procedures prior to any installation, setup, or maintenance work.

#### 3.1 Personal Safety

Operation of the CaviBlaster 3040-E60 underwater cleaning system must only be attempted by commercial divers or other personnel who have been trained in its use. Appropriate protective equipment should always be worn. Operation of the system without the proper equipment and training can result in personal injury.



CAVIDYNE LLC is not responsible for damages resulting from a failure to comply with instructions in this manual. Please read carefully before use.



If maintenance or repair of the CaviBlaster gun is being conducted out of the water, remember that the zero-thrust gun has front and rear jets. Never direct the jet streams at a person or animal. Never direct the jet streams toward power lines or other high voltage equipment.



Ensure that there is a safe area to work while operating the CaviBlaster 3040-E60.



Seek immediate medical attention if the operator suffers an injury as the result of contact with the high-pressure water stream. **Serious personal injury can result from an untreated water injection wound.**

### 3.2 Personal Protective Equipment

Always wear appropriate Personal Protective Equipment (PPE) when operating this equipment.

If the diver is not wearing a diving helmet, hearing protection is recommended. CAVIDYNE suggest wearing vented earplugs, such as “Doc’s Proplugs”, for diver hearing protection.

The operators of the CaviBlaster system should always wear neoprene or heavy rubber gloves to provide protection to the hands and, in particular, to the nails. The gloves will absorb most of the energy produced by bursting cavitation bubbles and prevent the cavitation bubbles from contacting the operators’ hands. The gloves will also protect operators’ hands from the initial shockwave when the zero-thrust gun is activated.



Failure to wear appropriate PPE may result in personal injury.

### 3.3 Modification to the Equipment

Do not make any unauthorized modifications or repairs to this equipment. Components used throughout this assembly were specifically designed or selected to safely meet the unique high-pressure requirements. Only replace parts with those recommended by or supplied by CAVIDYNE LLC. Any unapproved modifications will void the equipment warranty. Unauthorized modification or part substitution can result in serious personal injury or property damage.



**Unauthorized replacement of any part may lead to catastrophic equipment failure and serious personal injury.**



**Use of guns or pressure nozzles other than those supplied or specified by the manufacturer may lead to catastrophic equipment failure and serious personal injury.**

**This space intentionally left blank**

**(EOS)**

## 4.0 INSTALLATION

---

The CaviBlaster 3040-E60 must be installed in accordance with the requirements outlined below. The unit can be installed in a vehicle to allow for maximum mobility and flexibility.

### 4.1 Uncrating and Lifting

Unpack the equipment and inspect for damage. If damage is found, immediately contact CAVIDYNE LLC and the shipping company. *If the unit will not be installed immediately, provide adequate indoor storage to protect against damage.* If there are missing parts/spare parts, contact freight carrier or insurance company.

The CaviBlaster power unit should be lifted from underneath the frame using the forklift channels or by using the lifting eyes provided on top of the frame. Verify that lifting equipment is rated for the weight listed in Section 1.0 *UNIT SPECIFICATIONS* and that the unit is stable before lifting.

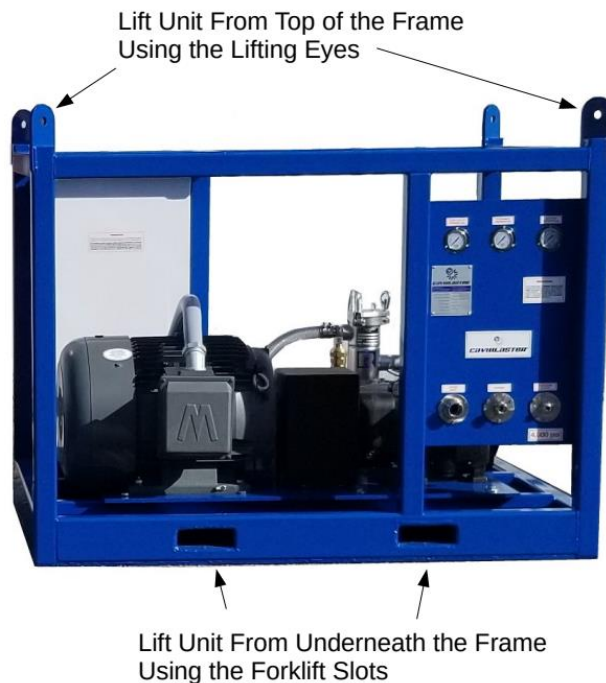

Figure 4.1 – Lifting Guidelines

## 4.2 Installation Location

For maximum flexibility the CaviBlaster power unit should be installed in an area where it is capable of reaching both its electric and water source and anticipated cleaning targets within acceptable power cable and hose lengths. The CaviBlaster power unit can be installed in an enclosed\* or open environment.

**\* Enclosed installations will require provisions for adequate motor cooling air flow. See Figure 4.2 below.**

Installation location must be a level surface able to safely support the unit weight listed in Section 1.0 *UNIT SPECIFICATIONS*. Orient unit to allow unrestricted access to the hose connection plate and control panel, located on the front of the unit. Allow a minimum of three feet behind the unit and access from above to conduct service and repair work. Take note of frequently serviced areas such as the in-line strainers and motor couplings.

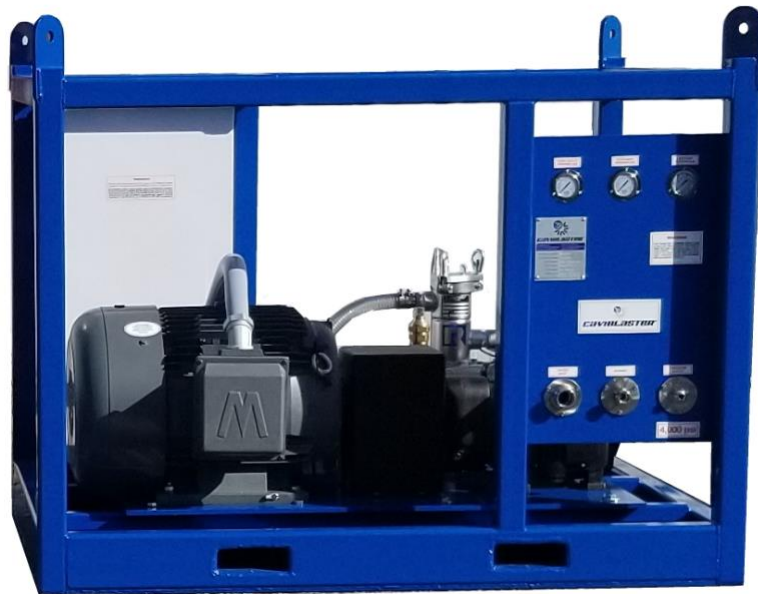

- ✓ Allow Access For General Service
- ✓ Allow Access To The Hose Connections Panel
- ✓ Allow Access To Electric Panel

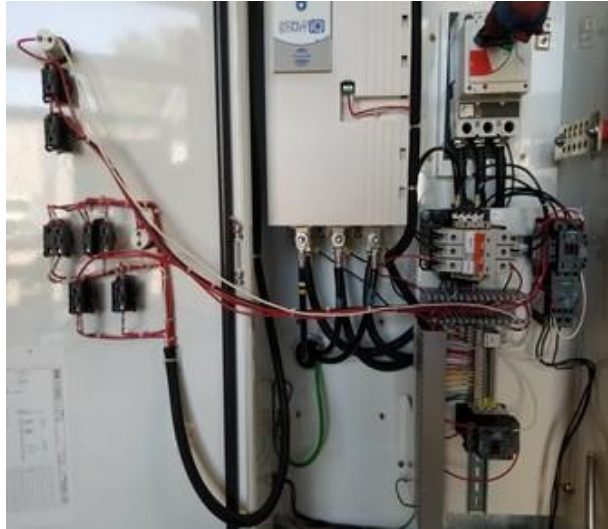

Figure 4.2 – Installation Guidelines

### 4.3 Initial Set-Up

After first receiving the CaviBlaster power unit, the following must be checked and completed:

- 1) Check / Add pump oil (See Pump Manual located in the *APPENDIX*).
- 2) Push in the Emergency Motor Shutoff (E-Stop) button.
- 3) Turn the main power to the OFF position.
- 4) Turn the HPP motor switch, SW1, to the OFF position.
- 5) Turn the feed pump switch, SW2, to the OFF position.
- 6) Connect the power cable (not provided) for the unit to the power source. Refer to Page 5 of this manual and consult local electric codes for cable power requirements.
- 7) **Confirm correct rotation of Feed Pump Unit. Reverse power cable wiring to achieve correct rotation.**
- 8) Close and lock the control panel door.
- 9) Connect the feed or suction hose (See Section 4.3.2).
- 10) Connect the bypass hose (See Figure 2.2).
- 11) Connect the pressure hose (See Figure 2.2).





Pump oil may have been removed for shipment. Check oil level prior to starting.

### 4.3.1 Connecting the Water Source

The CaviBlaster power unit can be used with seawater or fresh water. Note the unit must be flushed with fresh water for 1-2 minutes after each use in seawater to ensure long service life.

An electric boost pump is installed to provide positive inlet water pressure to the main pressure pump. The power unit incorporates a high-flow centrifugal feed pump to support the main pump system. The feed pump is capable of providing 50 to 70 GPM of water for the system.

### 4.3.2 Priming the System Using the Feed Pump System

Attention to priming the system is necessary. The feed water suction hose inlet connection is located on the water connection panel (See Figure 2.2). The (clear) suction hose should be straight and at a slight downward angle from the inlet connection on the water connection panel, with no “humps” in the hose so that trapping of air pockets and creating an air lock is minimized. During the priming cycle the suction hose should always remain below the height of the inlet connection unless connecting with a positive pressure water source.

**Note:** Assure that no air is trapped in the feed hose to cause an air lock leading to the feed pump.

The feed pump system is fully capable of self-priming. The feed pump should be charged with water to more effectively draw from the source. It is suggested a positive pressure water source be utilized to initially charge the feed pump system.

**Note:** The feed pump may require upwards of 5 to 7 minutes to draw sufficient water to prime the system before starting the main pump system.

Once fully primed should a restart be needed, confirm priming is complete, without trapped air pockets.

### 4.3.3 Water Supply Conditions.

- a) Forced inlet water condition using the supplied electric water pump.
- b) An outside water source capable of supplying a minimum of 40 GPM (150 LPM) at a **maximum pressure of 50-PSI (3.5 BAR)**.
- c) Gravity feeding water source (See Figure 4.3). Use a hose with a diameter of at least 1-1/2" to connect the water tank to the power unit water inlet.

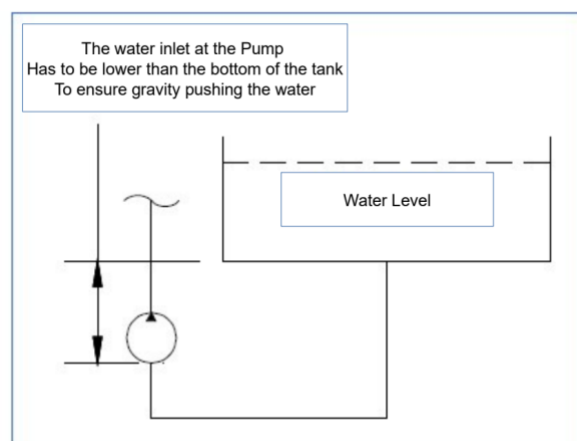

Figure 4.3 – Gravity Feeding Source

#### a) Using the Feed Pump System:

- Verify the main power switch, HPP motor switch and feed pump motor are switched to OFF.
- Ensure the E-Stop button is '**Pushed In**' so that the power supply has been disconnected. (See Figure 2.2).
- Connect the cam-lock socket on the 1-1/2" clear PVC feed hose to the water inlet connection on the control panel (See Figure 2.2). Place the other end of the hose in the water supply.
- **THE PUMP SYSTEM MUST BE FULLY PRIMED BEFORE STARTING THE HPP PUMP OR SERIOUS DAMAGE TO HPP PUMP WILL OCCUR. REFER TO SECTION 4.3.2 (ABOVE) FOR PRIMING INSTRUCTIONS.**

## **b) Using Force Feed Supply from an alternate source:**

- Verify the main power switch, HPP motor switch and feed pump motor are switched to OFF.
- Ensure the E-Stop button is '**Pushed In**' so that the power supply has been disconnected. (See Figure 2.2).
- When feeding the CaviBlaster with an alternate water source, **the source must be capable to supply water at a volume of greater than 28 gallons per minute (106 LPM) at a maximum pressure of 50-psi.**
- Connect a 1-1/2" cam-lock socket on the water supply hose to the water inlet connection on the control panel (See Figure 2.2). Confirm system is primed.

## **c) To Use Gravity Feed:**

- Locate the water supply tank so that the outlet of the supply tank is higher than the water inlet on the control panel (See Figures 2.2 and 4.3).
- Verify the main power switch, HPP motor switch and feed pump motor are switched to OFF.
- Ensure the E-Stop button is '**Pushed In**' so that the power supply has been disconnected. (See Figure 2.2).
- Connect a hose (minimum 1-1/2" diameter) to the water inlet (1-1/2" cam-lock plug). Connect the other end of the hose to the water supply tank outlet.
- Open any valves installed in the water supply line.
- Make sure the lowest point in the hose line is the connection with the power unit.
- **THE PUMP SYSTEM MUST BE FULLY PRIMED BEFORE STARTING THE HPP PUMP OR SERIOUS DAMAGE TO HPP PUMP WILL OCCUR. REFER TO SECTION 4.3.2 ABOVE FOR PRIMING INSTRUCTIONS.**
- **It is essential that adequate water is supplied to the water supply tank to maintain the water level several inches above the tank outlet. Failure to maintain an adequate water level in the supply tank during operation could starve the pressure pump of water causing damage to the seals or other components of the pressure pump.**

Ensure that the water source can reliably deliver the maximum pump flow of 30 GPM (115 LPM). **A minimum flow of 40 GPM (150 LPM) is recommended** to ensure that the pump is not starved of water. If connecting to a gravity feed tank, locate the tank outlet above the water inlet connection on the power unit to ensure a flooded suction line. (See Figure 4.3).



Ensure that the feed hose is connected to the inlet connection and the water supply is on prior to starting the pressure pump. Failure to supply water to the pressure pump will cause damage to the pump.

**(EOS)**

## 5.0 OPERATION

---

The CaviBlaster 3040-E60 should be operated by two (2) properly trained individuals. One, the diver, operates the zero-thrust gun, while the other operates the power unit. Both operators should be in audio or visual communication with each other.



The CaviBlaster 3040-E60 should only be operated by properly trained personnel who are familiar with the contents of the manual. Review the safety requirements found in Section 3.0 before operating.

### 5.1 Preparing the CaviBlaster for Operation

The following checklist should be completed in advance, so that the unit is always ready for immediate use. This should also be completed after each use.

- 1) Inspect the CaviBlaster power unit, electric power cord, hoses, JIC fittings and gun for any signs of damage.
- 2) Check that the motor is clean and ventilation openings are clear.
- 3) Inspect the inline strainer and filter media, to ensure that neither are clogged (See Figure 6.1). Clean or replace as necessary.
- 4) Check for proper pressure pump oil level (See pump Owner's Manual found in the *Appendix*). Add oil (SAE 30 non-detergent) if necessary.

### 5.2 Startup of the CaviBlaster

Before starting the CaviBlaster 3040-E60 power unit, review all safety requirements found in Section 3.0 *SAFETY INFORMATION*. This equipment should only be operated by individuals who have read and understand the CaviBlaster Operation and Maintenance Manual.

- 1) Verify that the unit has been properly prepared for operation as described in Section 4.
- 2) Unroll sufficient length of hose to reach the operating location and connect the gun to the high-pressure hose

- 3) Turn the E-Stop button and pull out to release (See Figure 5.1).
- 4) Turn the main power switch ON.
- 5) Turn the feed pump switch, SW2, ON and wait for the indicator light to turn on.
- 6) Turn the HPP motor switch, SW1, ON and wait for the indicator light to turn on. Note that the motor is equipped with a “soft start” starter and takes 3-4 seconds for the motor to start after being turned ON.
- 7) When the diver is ready to commence cleaning operations, ensure that the system is properly and fully primed and the diver gun is submerged in water. If the diver is not wearing a helmet, hearing protection is recommended. CAVIDYNE LLC suggests vented earplugs such as “Doc’s Proplugs” for diver hearing protection.
- 8) **Wear neoprene or rubber gloves to protect the hands and follow all safety regulations that may be applicable to the work being performed.**
- 9) Pull the gun trigger to the open or ON position. (See figure 5.3)
- 10) The system is now ready to operate.



### 5.3 Normal Operation

Normal operation of the CaviBlaster system is defined as user control of water flow via the gun trigger. Control of the power unit from the gun trigger is accomplished by a mechanical shut-off valve in the gun. Should a problem develop with the control valve, discontinue using the CaviBlaster until fixed.



- 1) Startup the power unit as described in Section 5.2.
- 2) Activate the cleaning cavitation stream by squeezing the trigger to the open or “ON” position (See Figure 5.3). Release trigger to stop the water flow and direct to bypass.
- 3) If the diver operating the unit must be replaced or the cleaning operation must be interrupted or terminated, turn the unit off **and then release the water pressure in the hose(s) by squeezing the gun trigger to the open or “ON” position (See Figure 5.3) while under water.** Revert back to step 5.2 of the operating instructions when the diver or replacement is ready to continue cleaning.



Although the CaviBlaster system is safe to use when submerged in water, the system generates a high-pressure (up to 4,000 psi (276 Bar)) water stream, which can cause injury when the gun is out of the water. **ALWAYS** keep the gun submerged when the pressure pump is running.

## 5.4 Adjusting the CaviBlaster for Maximum Performance

The pressure at the nozzle of the zero-thrust gun has to be maintained within certain limits to achieve cavitation and for best performance results. Using a calibration pressure gauge tool situated between the pressure hose and the CaviBlaster zero-thrust gun, (See Figure 5.2) the water pressure should be 4,000 psi (276 BAR) with the gun submerged and the gun trigger in the open or “ON” position. For best results, repeat this calibration procedure if cleaning performance degrades, or every 3 months at a minimum.



A calibration gauge is recommended with every unit. Connect between the main pressure hose and the whip hose or gun. See figure 5.2.

To calibrate the pressure at the zero-thrust gun, follow the procedure below:

- Stop the power unit and pull the gun trigger to discharge any residual pressure in the hose lines.
- Disconnect the gun with its whip hose from the main pressure hose line.

- Attach the calibration gauge to the main pressure hose line and attach the whip hose to the pressure gage. Tighten the JIC connections.
- Submerge the gun because of the danger of the operator coming in contact with either of the water streams from the cavitating or zero-thrust nozzles, **Cavidyne does NOT recommend calibrating the gun out of the water. Use extra care to avoid both water streams if doing so.**
- Ensure that both the cavitation and zero-thrust nozzles are pointed away from the diver's or operator's hands, arms and body.
- Start the power unit (See Section 5.2).
- Pull the gun trigger to the open or "ON" position (See Figure 5.3).
- Hold the gun tight and observe the calibration gauge (See Figure 5.2).
- The power unit operator should turn the knob on top of the pressure regulating valve until pressure reads 4,000 psi (276 BAR) on the calibration gauge at the Z/T Gun. Turning the knob clockwise will increase the pressure and turning it counter clockwise will decrease the pressure.



Do not adjust the pressure at the gun to more than 4,000-psi (276 bar). Higher pressure will not improve performance.



Hoses are rated for 5,000 psi (344 Bar). Pressures above 4,000-psi (276 Bar) could result in pump and / or hose failure.



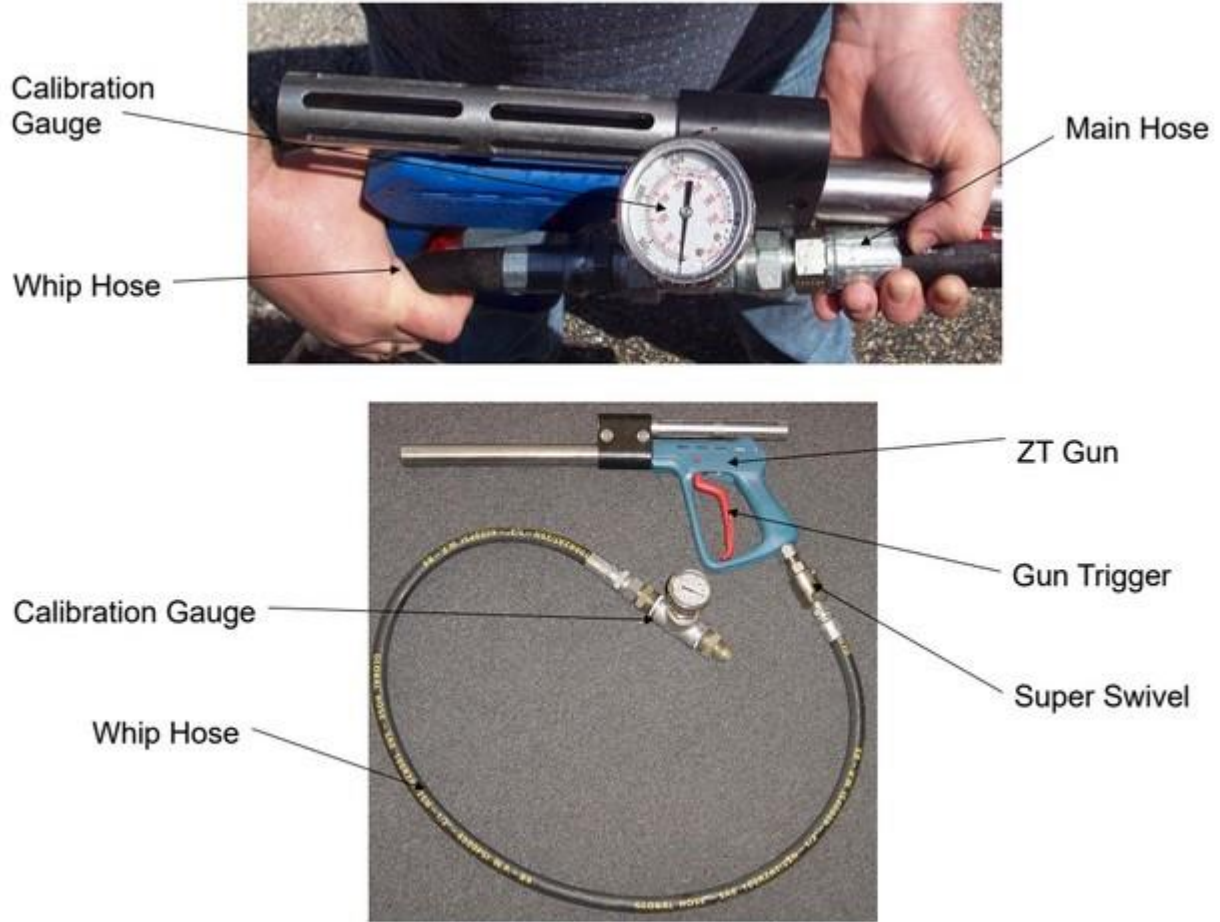

Figure 5.1 – Zero-thrust gun Pressure Calibration

## 5.5 Recommendations for Effective Results

Once the unit is operating at normal speed and the gun trigger is pulled, the diver has to find the most effective distance between the gun nozzle and the surface being cleaned.

When the diver is ready to commence cleaning operations, ensure that the gun trigger is in the open or “ON” position (See Figure 5.3), the gun is submerged in the water and the feed pump is operating prior to starting the electric motor. Ensure that the power unit operator and other people working in the vicinity of the power unit wear appropriate hearing protection when the unit is running.

1. Engage the pressure pump by turning the start-up by-pass valve to the “CLOSED” position (See Figure 5.1).
2. The most efficient operating technique is to hold the nozzle 2-5 inches (5-12 cm) away from the surface to be cleaned and at a 25 to 45 degree angle to the surface being cleaned (See Figure 5.3). The diver needs to observe the shape of the cavitating jet cone. At greater depths, the higher ambient pressure will cause the jet cone to be shorter. The widest zone of the cone is the most efficient part of the cavitating jet. Placing the nozzle closer than 2 inches (5 cm) from the surface being cleaned will not allow for efficient cavitation performance and will degrade the cleaning capability of the CaviBlaster system.
3. Follow all safety regulations that may be applicable to the work being performed.
4. If the diver operating the unit must be replaced or the cleaning operation must be interrupted or terminated, turn the unit off **and then release the water pressure in the hose(s) by squeezing the gun trigger to the open or “ON” position (See Figure 5.3) while under water.** Revert back to step 5.2 of the operating instructions when the diver or replacement is ready to continue cleaning.

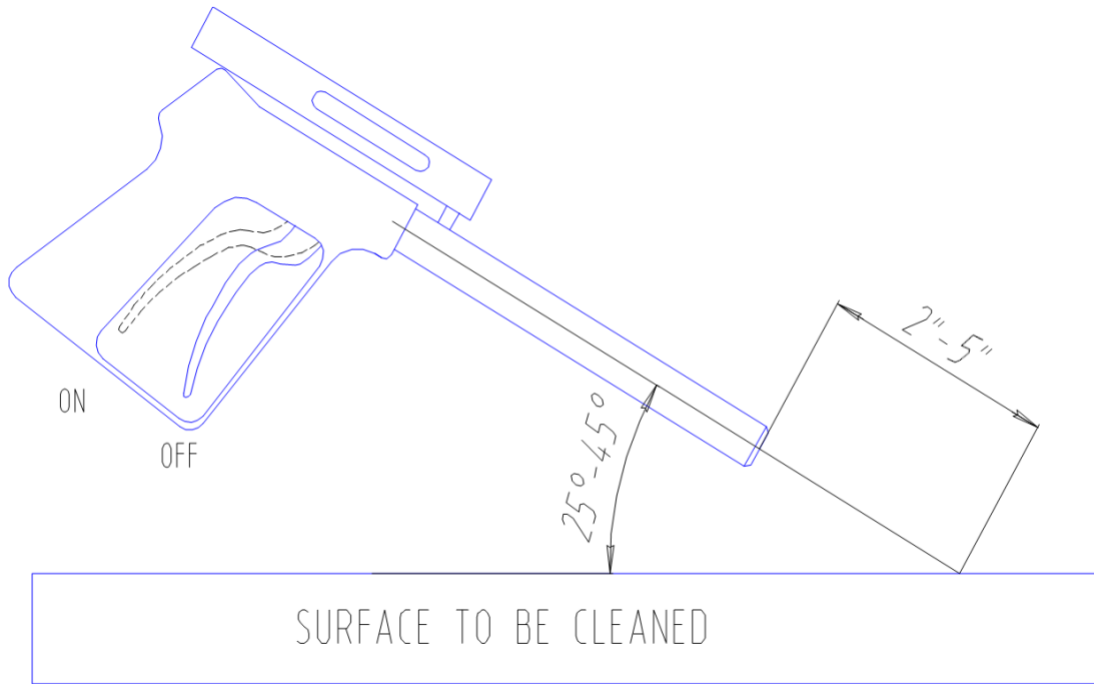

*Figure 5.2 – Zero-thrust Gun Position for Best Results*

**This space intentionally left blank**

## 5.6 Shutting Down the CaviBlaster

1. Stop the motor by turning the HPP motor switch, SW1, to the OFF position (See Figure 2.2).
2. Turn the feed pump switch, SW2, to the OFF position (See Figure 2.2). If using force feed from an alternate source or if using gravity feed, shut off the supply of water to the pressure pump.
3. Turn the main switch to the OFF position.
4. Push in the E-Stop button.
5. Squeeze the gun trigger to the open or "ON" position (See Figure 5.3) to release the water pressure remaining in the hose(s) **while the gun is submerged**.
6. It is now safe to remove the gun from the water.
7. Flush the system and rinse the power unit with fresh water at the end of the day if the system has been used with seawater.

**This space intentionally left blank**

**EOS**

## 6.0 MAINTENANCE

---

Maintenance on this unit should be restricted to authorized personal that have been properly trained. Review this manual, especially Section 3.0 *SAFETY INFORMATION*, prior to performing any service on this equipment.



Equipment must be OFF and pressure released from all hoses prior to performing any service work.



Only replace parts with those supplied or approved by CAVIDYNE. Use of any other parts may lead to equipment failure and severe personal injury.



CaviBlaster must be flushed and rinsed with fresh water after each use in sea water.



Failure to flush and rinse the unit will result in premature wear and tear on the components and decreased service life.



Failure to flush and rinse the unit can cause the pump valve(s) to stick in the open position. This will prevent the system from producing the correct operating pressure.

## 6.1 Basic Preventive Maintenance Recommendations

	Before and After Every Use	Every 6 Months or 125 Hours*	Every 6 Months or 500 Hours*	Every 12 Months or 500 Hours*	Every 1,000 Hours	Every 4 Years or 7,500 Hours*
Check pump oil level and add if low	X					
Check in-line strainer cartridge and clean if necessary	X					
Inspect hoses for wear or damage <sup>1</sup>	X					
Check gun trigger for leakage and repair if necessary <sup>2</sup>		X				
Check integrity of motor winding insulation with “megger” test			X			
Replace pump oil <sup>3</sup>				X		
Check pump valves and seals for wear & change if necessary					X	
Lubricate motor bearings with high grade ball or roller bearing grease						X

\* Whichever occurs first.

- 1) If any hose damage is found, replace hose immediately.
- 2) Remove gun from water with system at operating pressure and trigger in the closed or “OFF” position. If water is leaking out of barrel or handle, the gun trigger valve is worn and should be replaced.
- 3) The initial oil change is after 50 hours of operation. See pump manufacturer’s literature in the Appendix for additional recommendations.

## 6.2 Pump Service

The high pressure water pump requires minimal maintenance. The pump oil level should be checked on a regular basis. The pump crankcase with Gear box holds 9 liters (304 US fluid ounce), of SAE 80W 90 viscosity non-detergent oil. See pump manufacturer’s literature found in the *APPENDIX* for further information.

### 6.3 Inspection/Cleaning of Water Inlet Strainer

The water inlet strainer and the water filter should be inspected before and after each use of the CaviBlaster 3040-E60. To inspect and clean the strainer or filter, follow the procedure below:

- 1) Turn the main power switch OFF and isolate or disconnect the water source from the inlet connection to the power unit.
- 2) Unscrew the strainer bowl from the housing (turn CCW) (See Figure 6.1).
- 3) Pull the bowl down and remove the filter/strainer.
- 4) Inspect the filter/strainer and flush any debris clean with clean water.
- 5) Push filter/strainer back into housing and push the bowl back onto filter housing.
- 6) Thread the bowl CW onto the housing nut to hand tighten.
- 7) Loosen and remove cap of main filter Assy.
- 8) Lift filter media from housing and inspect for debris. Rinse or replace media as necessary.
- 9) Inspect O-ring under the cap for damage. Replace cap and tighten.

#### Inlet Filter

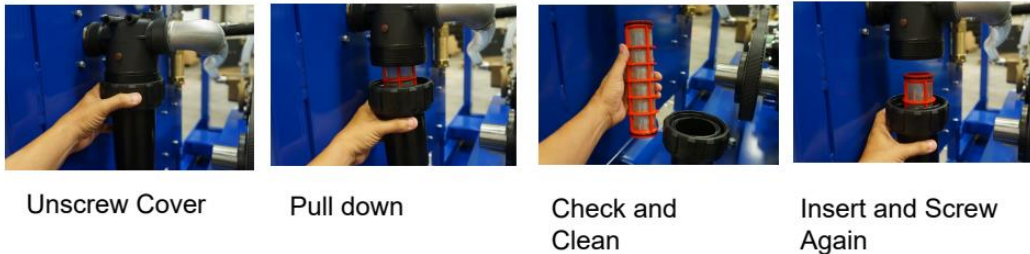

#### Main Filter

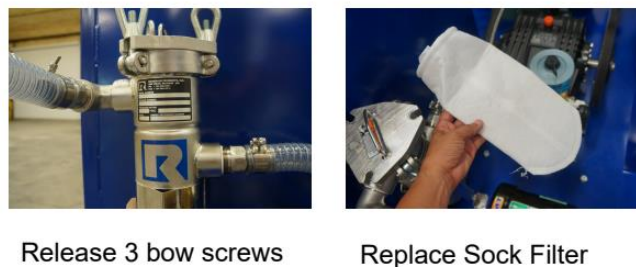

Figure 6.1 – Inspection / Cleaning Water Filter/Strainer

## 6.4 Inspection / Maintenance of the Zero-Thrust Gun

In order to minimize potential problems with the Zero-Thrust Gun it is recommended that the gun be inspected and maintained at the end of each work period:

1. Flush and rinse the gun with fresh water after each use in sea water.
2. If the unit will be used in the next 24 hours, place the gun in a container of clean, fresh water. Ensure the gun is completely submerged.
3. If the gun will **not** be used for a period of several days, flush the gun as noted, remove the whip hose from the super swivel. With the gun turned upside-down, pour approx. 5ml of lubricating oil into the water inlet of the gun while opening and closing the trigger to allow oil to reach the positioning pin and valve cone. This will minimize the possibility of corrosion or mineral crystals from forming that would freeze the pin or valve cone.
4. **Do not** use WD-40 for long term storage.



*Figure 6.2 – Zero-Thrust Gun*

(EOS)



## 7.0 WINTERIZATION

---

The power unit should be winterized if stored at temperatures below 32 degrees Fahrenheit (0 degrees Celsius).

Total system displacement with 100 ft of hose (optional): 4.3 gallons.

Total system displacement without hose: 2.0 gallons.

To winterize the CaviBlaster 3040-E60 power unit:

1. Fill a 5 gallon (19 liter) or larger container with appropriate antifreeze solution.
2. Connect a 1-1/2" cam-lock socket with a minimum amount of 1-1/2" clear hose to the water inlet connection on the control panel (See Figure 2.2) and place the open end of the clear hose into the antifreeze solution.
3. Attach a minimal amount of pressure hose to the pressure connection on the control panel (See Figure 2.2) and direct the open outlet of the hose into the antifreeze tank.
4. Attach a minimum amount of hose to the start-up by-pass valve and place the open end into the antifreeze tank.
5. Open the start-up by-pass valve and start the unit and make sure the pump is primed.
6. Close the start-up by-pass valve and run the unit until antifreeze comes out of the open end of the pressure hose for 10 seconds.
7. Stop the unit and disconnect all hoses.

Following this procedure will ensure that all the critical system components exposed to water have been flushed with antifreeze.

**This space intentionally left blank**

**(EOS)**

## 8.0 TROUBLESHOOTING

---

### 1. MOTOR WILL NOT START

#### -Make sure “Emergency Stop” is not engaged

- Make sure all three phases are live and the ground circuit is complete
- Check circuit breakers to make sure they are set “on”
- Check master disconnect to insure that it is “on”

### 2. MOTOR HUMS EXCESSIVELY

- Check input line connections for proper voltage
- Check motor contactor for proper

### 3. MOTOR OVERHEATS

- Overload – compare actual (measured) amps with nameplate rating  
Locate and remove source of excessive friction in motor or load
- Single phasing – check current at all phases (should be approximately equal to isolate and correct the problem
- Improper ventilation  
Check external cooling fan to ensure air is moving across cooling fins  
Excessive dirt build-up on motor – clean motor
- Unbalanced voltage - check voltage at all phases (should be approximately equal to isolate and correct the problem
- Rotor rubbing on stator  
Check air gap clearance and bearings  
Tighten “thru bolts”
- Over voltage or under voltage – check input voltage at each phase
- Open stator winding – check stator balance at all phases for balance
- Grounded winding – perform dielectric test and repair
- Improper connections – inspect all connections for proper termination, clearance, mechanical strength and electrical continuity

### 4. BEARING OVERHEATS

- Misalignment – check and align motor and pump
- Excessive end thrust from pump
- Excessive or insufficient grease in bearing – cavity should be  $\frac{3}{4}$  filled
- Dirt in bearing – clean bearing and cavity and refill approximately  $\frac{3}{4}$  full

### 5. VIBRATION

- Misalignment – check and align motor and pump
- Rubbing between rotating and stationary parts
- Rotor out of balance
- Resonance – tune system

## **6. GROWLING OR WHINING**

- Bad bearing – replace bearing and repack with correct grease

## **7. MOTOR RUNS, BUT WATER DOES NOT COME OUT OF THE GUN**

- Verify inlet water supply is functioning
- Ensure that the power unit is not located too far above the water level, exceeding the capacity of the feed pump
- Check that feed pump and inlet water strainers are clear
- Check for leaks in the water lines
- Check for an air-lock in the water inlet lines
- Verify that the feed pump is delivering water
  - Pump mechanical failure
  - Bad electrical connections
- Check that pressure pump inlet and discharge valves are not stuck open (common problem if not flushed after use with sea water)
- Check for water going out of the bypass – regulating unloader failure

## **8. WATER IN CRANK CASE**

- Check the pump seals for damage (feeding water at greater than 50-psi (3.4 bar) can force water past the seals and damage the seals and starving the pressure pump of water can overheat and damage the seals)
- Check the plungers for cracks
- Check the plunger rod O-ring for damage

## **9. AFTER RELEASING THE MECHANICAL TRIGGER, WATER IS STILL LEAKING OUT OF THE GUN**

- Replace the mechanical trigger valve assembly in the gun handle

## **10. ZERO-THRUST GUN IS NOT CLEANING PROPERLY**

- Verify that the system is operating at the correct pressure (4,000 psi; 276 BAR).
- Remove the zero-thrust gun from the water with the system at operating pressure and trigger in the closed or “OFF” position. If water is leaking out of the barrel or handle, the trigger valve assembly should be replaced.
- Check cavitation and zero-thrust nozzles for foreign particles
  - Visual inspection
  - With the unit turned OFF**, Insert a small wire into nozzle orifices to check for obstruction(s)
  - Remove trigger valve assembly and “back-flush” with compressed air or pressurized water

## 9.0 REPLACEMENT PARTS

---

<b>CaviBlaster 3040-E60 POWER UNIT REPLACEMENT PARTS</b>			
<b>RECOMMENDED ORDER QTY</b>	<b>QUANTITY PER ASSEMBLY</b>	<b>PART DESCRIPTION</b>	<b>PART NUMBER</b>
1	1	Main filter media (sock)	<b>CD-FILTER-BAG</b>
1	1	Inlet strainer cartridge	3260.02
1	1	Pump seal kit	04-KIT UD-139
1	1	Pump valve kit	04-KIT UD-142
1	1	Pump brass kit	04-KIT UD-140
1	1	Pump plunger rod O-ring kit	04-KIT UD-141
1	1	Pressure regulating unloader repair kit	UB
1	1	Trigger valve repair kit – small gun	202700490
1	1	Trigger valve repair kit – large gun	203300490

All parts can be  
ordered from:

### **CAVIDYNE, LLC**

5077 Fruitville Rd., Suite 109-157  
Sarasota, FL 34232  
Phone: (352) 275-5319  
[www.cavidyne.com](http://www.cavidyne.com)

**(EOS)**